

Single zone inverter mini split

MODEL: UHD09KCH38S

WILLIS

Job Name: _____

Location: _____

Engineer Name: _____

File Resubmit

Contractor: _____

System No: _____

Approval Other

Date: _____

General Features

- Ultra Heat
- Ultra Efficient
- Extended pipe length
- Wi-Fi
- Fan Delay Function
- Intelligent Pre-heating / Defrost
- LED display
- Control lock
- Auto Swing (Vertical&horizontal)
- Heated Belt Around Compressor
- Pan Heater
- High And Low Pressure Protection Features
- Load Protection Features
- Over-Current Protection
- Anti Freeze Protection



Unit Performance:

<i>Cooling:</i>	
Capacity (Min-Rated-Max, Btu/h)	1,535-9,000-12,996
SEER	38
EER	16,5
<i>Heating:</i>	
Capacity (Min-Rated-Max, Btu/h)	2,388-9,000-13,648
HSPF	15
COP (W/W)	4,4

Unit Specification

Refrigerant Type	R410A
Refrigerant Charge (oz)	45,9
ODU Sound Pressure (dB(A))	53
IDU Sound Pressure (dB(A))	43/40/38/36/33/31/19
ODU Net Weight (lbs)	99,2
IDU Net Weight (lbs)	29,8
Dehumidifying (Pint/h)	1,69

Fan

ODU / IDU Type	Axial-flow/Cross-flow
Quantity (ODU + IDU)	1+1
Motor/Drive	Direct Drive
ODU Max Air Flow Rate (CFM)	1413
IDU Air Flow Rate (CFM)	206/424

Compressor

Cooling Operation Ambient temp. Range	0~129°F
Heating Operation Ambient temp. Range	-22~75°F
Compressor Type	Rotary
Fan Motor Output (W)	30
Crankcase Heater	Yes

Electrical Specification

Power Supply	208-230V / 60Hz
Communications Wire Size	AWG 16
MOP (A)	15
MCA (A)	9
Cooling Rated Amps (A)	6,2
Heating Rated Amps (A)	6,9
Compressor RLA (A)	6,9
Indoor Fan Motor RLA (A)	0,09
Outdoor Fan Motor RLA (A)	0,24
Nominal Cooling Power Input (kW)	0,54
Nominal Heating Power Input (kW)	0,59

Piping

Liquid Line (in, OD)	1/4
Gas Line (in, OD)	1/2
Additional Refrigerant (oz./ft.)	0.2
Max Pipe Length (ft.)	49.2
Piping Length (no add'l refrigerant, ft.)	24.6
Max Elevation (ft.)	32.8



Capacity Variation Ratio According to Temperature

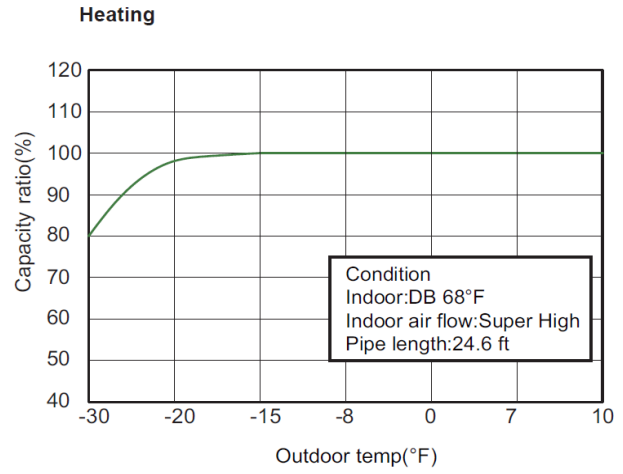
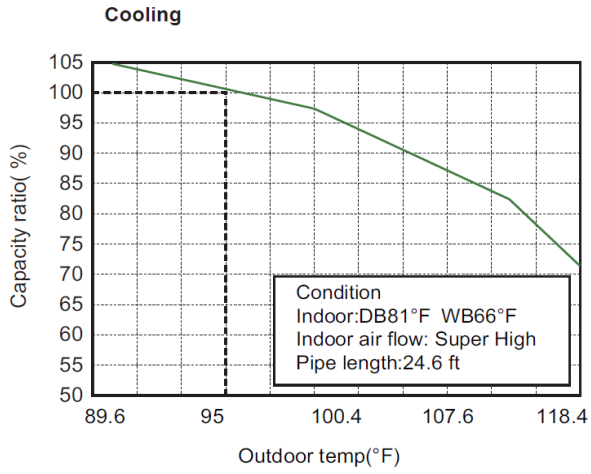

Single zone inverter mini split

MODEL: UHD09KCH38S

WILLIS

Outline Dimension Diagram

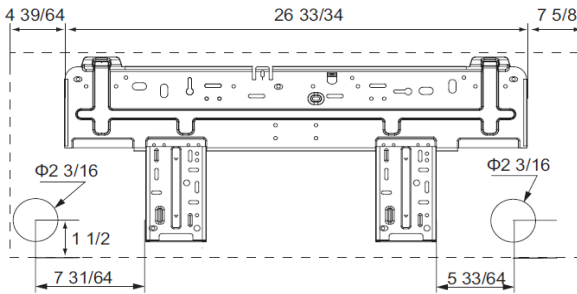
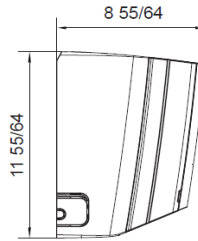
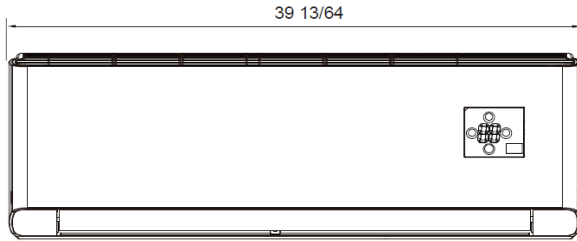

Unit:inch

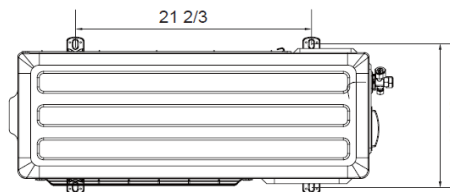
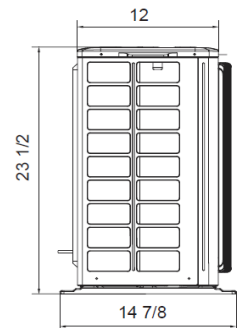
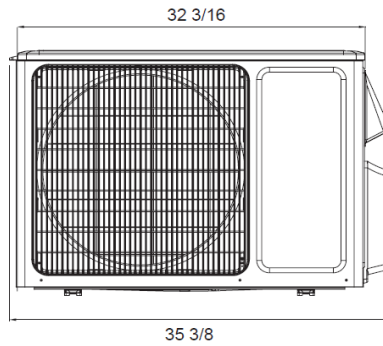

Unit:inch

GLOSSARY

SEER - Seasonal Energy Efficiency Ratio

EER - Energy Efficiency Ratio

HSPF - Heating Seasonal Performance Factor

MOP - Maximum Overcurrent Protection

MCA - Minimum Circuit Ampacity

WILLIS

5965 Chemin de la Côte de Liesse
Saint laurent, QC, Canada, H4T 1C3

Contact: +1 438 792 1956

info@willishvac.com

www.willishvac.com